



Specification for Approval

- DEVICE NUMBER: BL-HE1G033B-TRB



SAMPLES
ATTACHED AREA

DATE \ PAGE	1	2	3	4	5	6	7				CONTENTS
2017.01.11	1.0	1.0	1.0	1.0	1.0	1.0	1.0				Initial Released
2022.04.28	1.1	1.1	1.1	1.1	1.1	1.1	1.1				Standardization

FOR CUSTOMER'S APPROVAL STAMP OR SIGNATURE

APPROVED	PURCHASE	MANUFACTURE	QUALITY	ENGINEERING

佰鴻工業股份有限公司
 BRIGHT LED ELECTRONICS CORP.
 新北市板橋區和平路 19 號 3 樓
 3F., No.19, He Ping Road,
 Ban Qiao Dist., New Taipei City,
 Taiwan
 Tel: +886-2-29591090

Approved By	Confirmed By	Prepared By
		

● Features:

1. Emitted Color :Hi-Eff Red and Yellow Green
2. Lens Appearance : Water Clear.
3. Bi-color type.
4. 3.2x2.7x1.1mm(1210) standard package.
5. Suitable for all SMT assembly methods.
6. Compatible with infrared and vapor phase reflow solder process.
7. Compatible with automatic placement equipment.
8. This product doesn't contain restriction Substance, comply ROHS standard.

● Applications:

1. Backlighting : LCDs, Key pads advertising.
2. Status indicators : Consumer & industrial electronics.
3. General use.

● Package Dimensions:

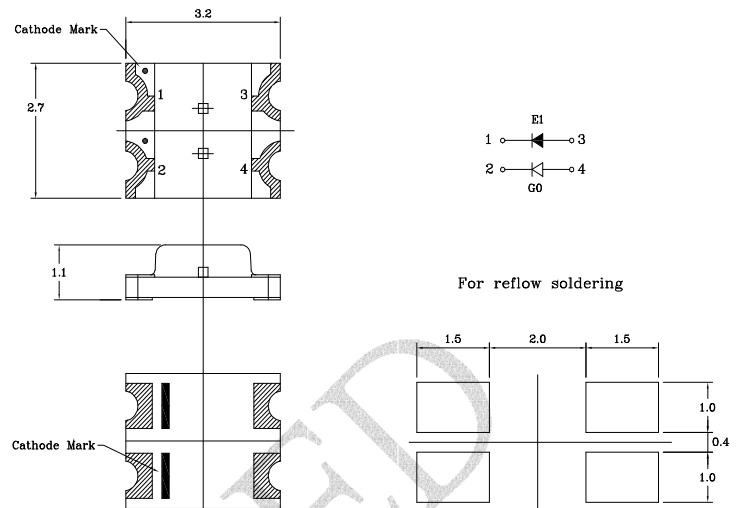

NOTES:

1. All dimensions are in millimeters.
2. Tolerance is ± 0.10 mm unless otherwise specified.
3. Specifications are subject to change without notice.

● Absolute Maximum Ratings(Ta=25°C)

Parameter	Symbol	Hi-Eff Red	Yellow Green	Unit
Power Dissipation	Pd	50	50	mW
Forward Current	I _F	20	20	mA
Peak Forward Current * 1	I _{FP}	100	100	mA
Reverse Voltage	V _R	5		V
Operating Temperature	Topr	-40°C ~85°C		-
Storage Temperature	Tstg	-40°C ~85°C		-
Soldering Temperature	Tsol	See Page 6		-

* 1 Condition for I_{FP} is pulse of 1/10 duty and 0.1msec width.

● Electrical and optical characteristics(Ta=25°C)

Parameter	Symbol	Condition	Color	Min.	Typ.	Max.	Unit
Forward Voltage	V _f	I _F =20mA	Hi-Eff Red Yellow Green	-	2.2 2.2	2.6 2.6	V
Luminous Intensity	I _v	I _F =20mA	Hi-Eff Red Yellow Green	3.7 3.7	10 10	-	mcd
Reverse Current	I _R	V _R =5V	Hi-Eff Red Yellow Green	-	-	100	μA
Peak Wave Length	λ _p	I _F =20mA	Hi-Eff Red Yellow Green	-	640 568	-	nm
Dominant Wave Length	λ _d	I _F =20mA	Hi-Eff Red Yellow Green	626 566		636 576	nm
Viewing Angle	2θ _{1/2}	I _F =20mA	Hi-Eff Red Yellow Green	-	120	-	deg

● Typical Electro-Optical Characteristics Curves

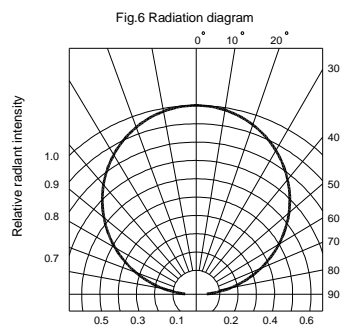
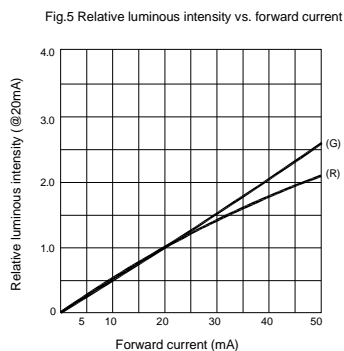
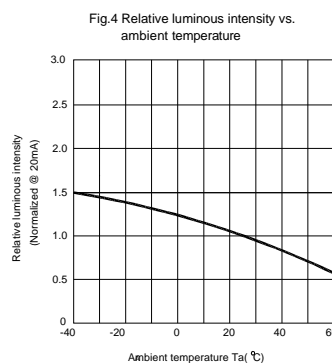
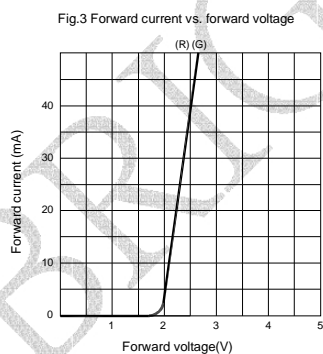
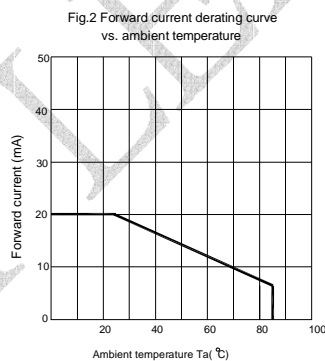
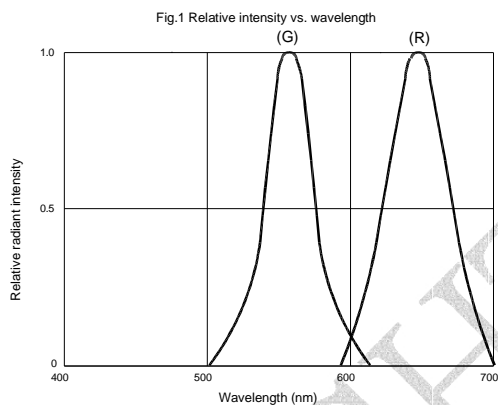

● Tapping and packaging specifications(Units: mm)

Quantity: 3000PCS

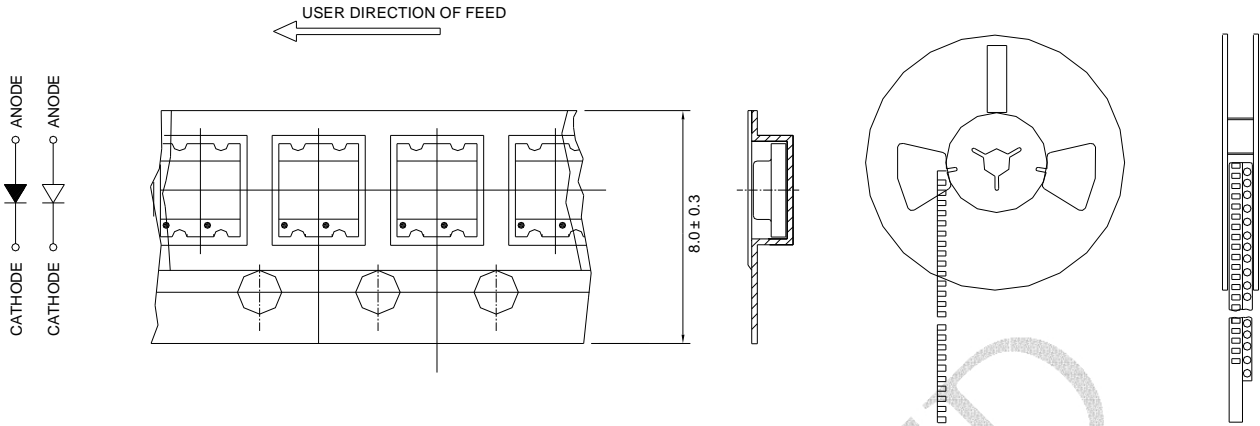

● Package Method:(unit:mm)Vacuum

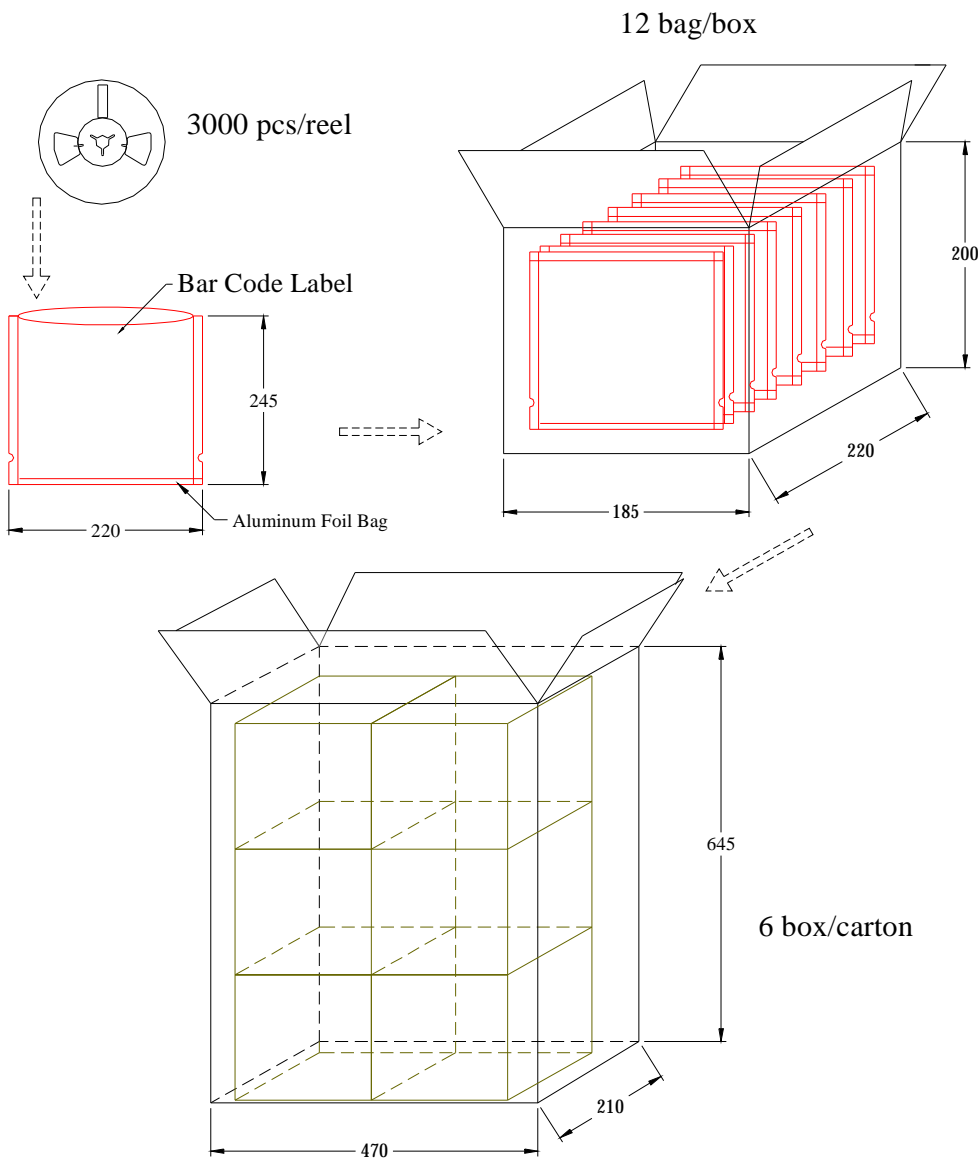

● **Bin Limits**

Intensity Bin Limits (E1) (At 20mA)

BIN CODE	Min. (mcd)	Max. (mcd)
G	3.7	5.5
H	5.5	8.2
J	8.2	12.3
K	12.3	18.5

Tolerance for each Bin limit is $\pm 15\%$.

Intensity Bin Limits (G0) (At 20mA)

BIN CODE	Min. (mcd)	Max. (mcd)
G	3.7	5.5
H	5.5	8.2
J	8.2	12.3
K	12.3	18.5

Tolerance for each Bin limit is $\pm 15\%$.

Color Bin Limits (G0) (At 20mA)

BIN CODE	Min. (nm)	Max. (nm)
4	566	568
5	568	570
6	570	572
7	572	574
8	574	576

Tolerance for each Bin limit is $\pm 1\text{ nm}$.

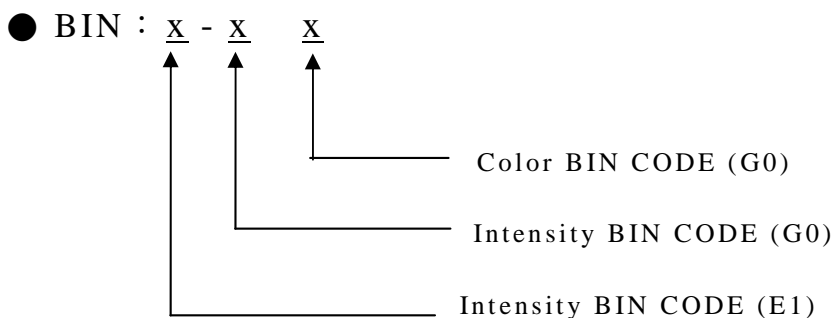

● Reliability Test

Classification	Test Item	Reference Standard	Test Conditions	Result
Endurance Test	Operation Life	MIL-STD-750D:1026 MIL-STD-883D:1005 JIS-C-7021 :B-1	Ta: Under room temperature Test time:1,000hrs IF=Product Recommended IF	0/32
	High Temperature High Humidity Storage	MIL-STD-202F:103B JIS-C-7021 :B-11	Ta:85±5°C RH:90%-95% Test time:240hrs	0/32
	High Temperature Storage	MIL-STD-883:1008 JIS-C-7021 :B-10	Ta:100±5°C Test time:1,000hrs	0/32
	Low Temperature Storage	JIS-C-7021 :B-11	Ta: -45±5°C Test time=1,000hrs	0/32
Environmental Test	Temperature Cycling	MIL-STD-202F:107D MIL-STD-750D:1051 MIL-STD-883D:1010 JIS-C-7021 :A-2	Ta:-35±5°C ~25±5°C ~85±5°C ~25±5°C 30min 5min 30min 5min Time: 5cycles	0/32
	Thermal Shock	MIL-STD-202F:107D(1980) MIL-STD-750D:1051(1995) MIL-STD-883D:1011(1991)	Ta:-45±5°C ~+85±5°C 20min 20 min Time: 10cycles	0/32
	Wetting balance	MIL-STD-883:2003 MIL-STD-202F:208D MIL-STD-883D:2003	Ta:230±5°C Time:5±0.5s	0/32
	Solder Resistance	MIL-STD-202F:210A MIL-STD-883D:1011 JIS-C-7021 :A-1	Ta:260±10°C Time:10±1s	0/32

● Judgment criteria of failure for the reliability

Measuring items	Symbol	Measuring conditions	Judgement criteria for failure
Forward voltage	V_F (V)	$I_F=20\text{mA}$	Initial Level*1.1
Reverse current	$I_R(\mu\text{A})$	$V_R=5\text{V}$	Over U*2
Luminous intensity	I_v (mcd)	$I_F=20\text{mA}$	Initial Level*0.7

Note: 1.U means the upper limit of specified characteristics.

2.Measurment shall be taken between 2 hours and after the test pieces have been returned to normal ambient conditions after completion of each test.

● IR-Reflow Soldering

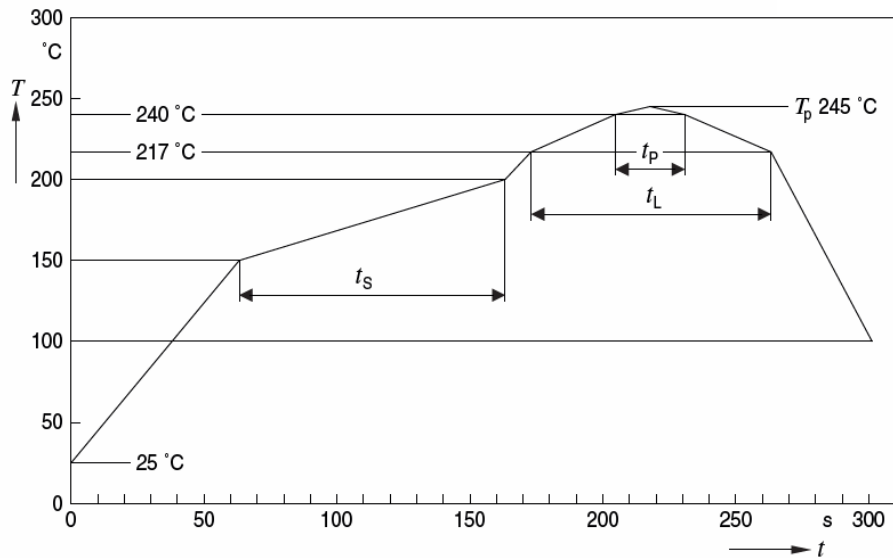

Profile Feature	Symbol	Pb-Free (SnAgCu) Assembly			Unit
		Minimum	Recommendation	Maximum	
Ramp-up rate to preheat ¹⁾ 25 °C to 150 °C			2	3	K/s
Time t_s T_{smin} to T_{smax}	t_s	60	100	120	s
Ramp-up rate to peak ¹⁾ T_{smax} to T_p			2	3	K/s
Liquidus temperature	T_L		217		°C
Time above liquidus temperature	t_L		80	100	s
Peak temperature	T_p		245	260	°C
Time within 5 °C of the specified peak temperature $T_p - 5$ K	t_p	10	20	30	s
Ramp-down rate* T_p to 100 °C			3	6	K/s
Time 25 °C to T_p				480	s

All temperatures refer to the center of the package, measured on the top of the component

* slope calculation DT/Dt : Dt max. 5 s; fulfillment for the whole T-range

1. Avoid any external stress applied to the resin while the LEDs are at high temperature, especially during soldering.
2. Avoid rapid cooling or any excess vibration during temperature ramp-down process.
3. Although the soldering condition is recommended above, soldering at the lowest possible temperature is feasible for the LEDs.

● IRON Soldering

350°C Within 3 sec., One time only.



● Notes for designing:

Care must be taken to provide the current limiting resistor in the circuit so as to drive the BRIGHT LEDs within the rated figures. Also, caution should be taken not to overload BRIGHT LEDs with instantaneous voltage at the turning ON and OFF of the circuit.

When using the pulse drive care must be taken to keep the average current within the rated figures. Also, the circuit should be designed so as to be subjected to reverse voltage when turning off the BRIGHT LEDs.

● Storage:

In order to avoid the absorption of moisture, it is recommended to solder BRIGHT LEDs as soon as possible after unpacking the sealed envelope.

If the envelope is still packed, to store it in the environment as following:

- (1) Temperature : 5°C-30°C (41°F) Humidity : RH 60% Max.
- (2) After this bag is opened, devices that will be applied to infrared reflow, vapor-phase reflow, or equivalent soldering process must be:
 - a. Completed within 168 hours.
 - b. Stored at less than 30% RH.
- (3) Devices require baking before mounting, if:
 - (2) a or (2) b is not met.
- (4) If baking is required, devices must be baked under below conditions:
 - 48 hours at 60°C±3°C.

● Package and Label of Products:

- (1) Package: Products are packed in one bag of 3000 pcs (one taping reel) and a label is attached on each bag.
- (2) Label:

