



Specification for Approval

- DEVICE NUMBER:BS-A554RD-B
- CUSTOMER:

SAMPLES
ATTACHED AREA

DATE	PAGE											CONTENTS
	1	2	3	4								
2016/11/23	1.0	1.0	1.0	1.0								Initial Released

FOR CUSTOMER'S APPROVAL STAMP OR SIGNATURE

APPROVED	PURCHASE	MANUFACTURE	QUALITY	ENGINEERING

佰鴻工業股份有限公司
 BRIGHT LED ELECTRONICS CORP.
 新北市板橋區和平路 19 號 3 樓
 3F., No.19, He Ping Road,
 Ban Qiao Dist., New Taipei City,
 Taiwan
 Tel: +886-2-29591090
 Fax: +886-2-29547006/29558809
www.brtled.com

ISSUED	APPROVED	PREPARED
張孝巖	郭初榮	蔡嘉榮

● **Features :**

1. 0.56 inch (14.20mm) Digit Height.
2. Continuous uniform segments.
3. Low power requirement.
4. Excellent characters appearance.
5. Solid state reliability.
6. Categorized for luminous intensity.
7. Direct drive common anode.

● **Description :**

1. The BS-A554RD-B is a 14.20mm (0.56") high single digit seven segments display.
2. This product use hi-eff red chips
3. This product have a black face and white segments.
4. This product doesn't contain restriction substance, comply ROHS standard.

● **Package Dimensions :**

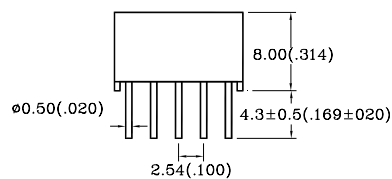
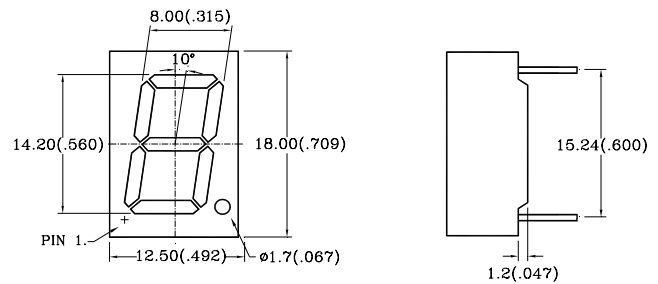

Notes:

1. All dimensions are in millimeters(inches).
2. Tolerance is ±0.25mm(.01")unless otherwise specified.
3. Specifications are subject to change without notice.

● **Internal Circuit Diagram :**

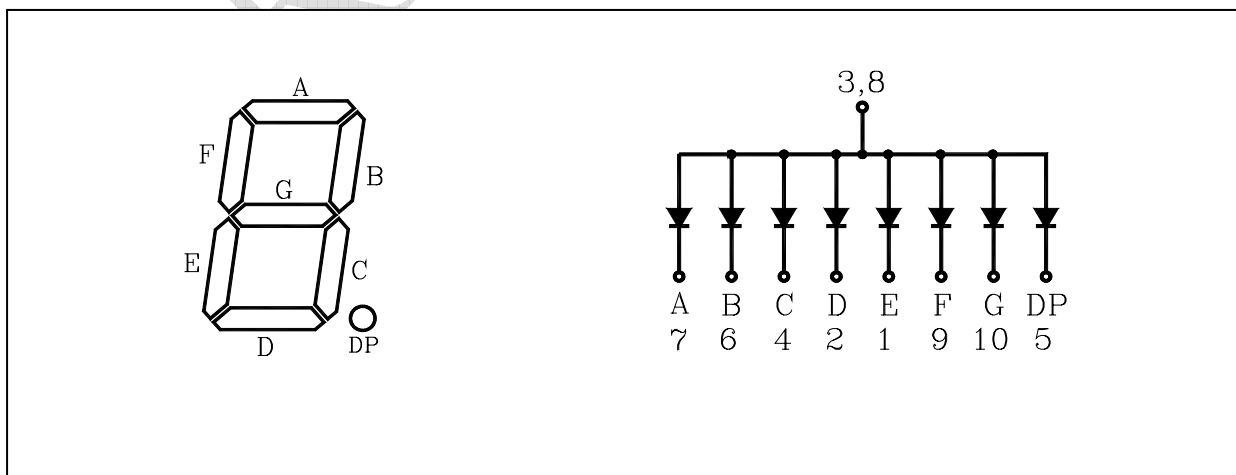



● Absolute Maximum Ratings(Ta=25°C)

Parameter	Symbol	Rating	Unit
Power Dissipation Per Segment	Pd	80	mW
Forward Current Per Segment	I _F	30	mA
Peak Forward Current Per Segment	I _{FP} (Duty 1/10, 1KHZ)	150	mA
Reverse Voltage Per Segment	V _R	5	V
Operating Temperature	Topr	-40°C~85°C	-
Storage Temperature	Tstg	-40°C~85°C	-
Soldering Temperature (1/16" From Body)	Tsol	260°C For 5 Seconds	-

● Electrical And Optical Characteristics(Ta=25°C)

Parameter	Symbol	Condition	Min.	Typ.	Max.	Unit
Forward Voltage Per Segment	V _f	I _F =10mA	-	1.9	2.5	V
Luminous Intensity Per Segment	I _v	I _F =10mA	-	3.0	-	mcd
Reverse Current Per Segment	I _R	V _R =5V	-	-	100	μA
Peak Wave Length	λ _p	I _F =20mA	-	640	-	nm
Dominant Wave Length	λ _d	I _F =20mA	626	-	636	nm
Spectral Line Half-width	Δλ	I _F =20mA	-	40	-	nm

● Typical Electro-Optical Characteristics Curves

(25°C Ambient Temperature Unless Otherwise Noted)

Fig.1 Relative Radiant Intensity VS. Wavelength

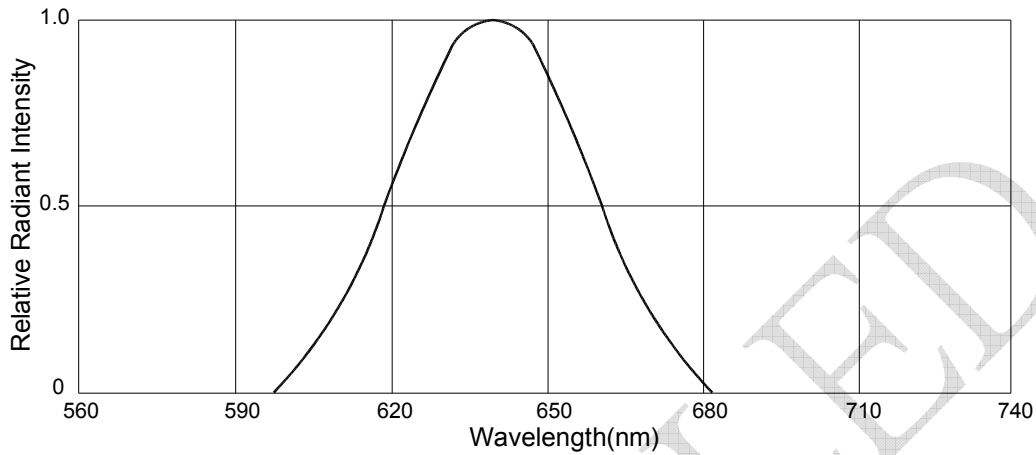

Fig.2 Forward Current VS. Forward Voltage

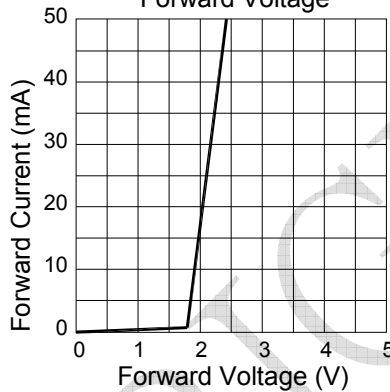

Fig.3 Relative Luminous Intensity VS. Ambient Temperature

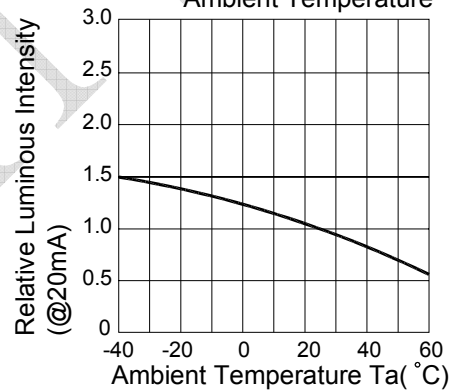

Fig.4 Relative Luminous Intensity VS. Forward Current

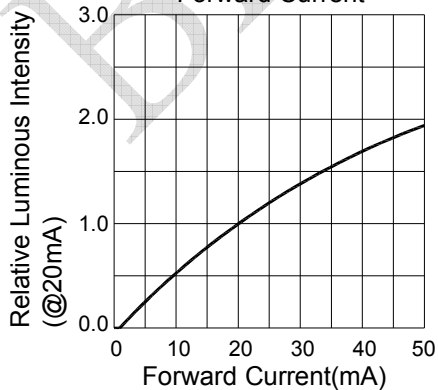
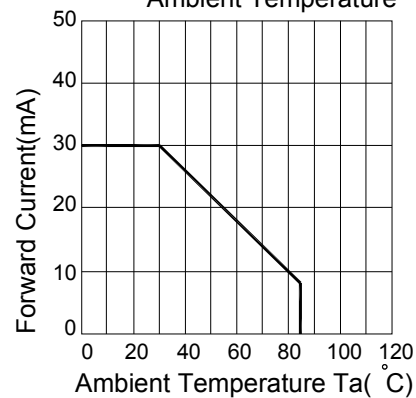
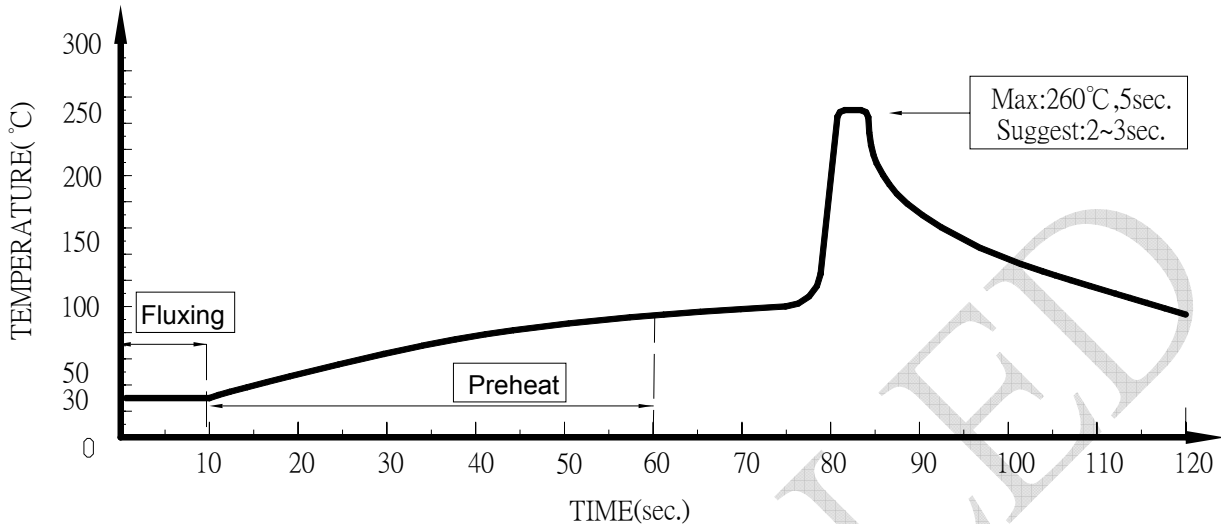

Fig.5 Forward Current Derating Curve VS. Ambient Temperature



● Dip Soldering



1. Please avoid any external stress applied to the lead-frames and epoxy while the LEDs are at high temperature, especially during soldering
2. DIP soldering and hand soldering should not be done more than one time.
3. After soldering, avoid the epoxy lens from mechanical shock or vibration until the LEDs are back to room temperature.
4. Avoid rapid cooling during temperature ramp-down process
5. Although the soldering condition is recommended above, soldering at the lowest possible temperature is feasible for the LEDs

● IRON Soldering

300°C Within 3 sec., One time only.